



For Air

Super Cupla

Light, compact for air piping connections

<p>Working pressure</p>  <p>1.0 MPa (10 kgf/cm²)</p>	<p>Valve structure</p>  <p>One-way shut-off</p>	<p>Applicable fluids</p>  <p>Air</p>
--	--	---

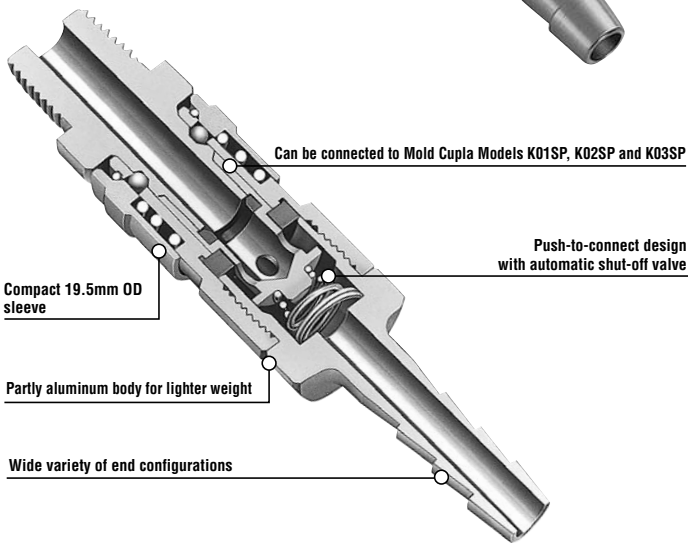

**The lightweight design makes the Cupla best suited to power tools!
Push-to-connect for easy operation.**

- Lightweight design suits direct connection to power tools. Aluminum body is adopted for some models to reduce the weight.
- Just push the plug into socket for easy one hand connection.
- Available in various end configurations for a wide range of pneumatic applications.
- Model 02S20P can be connected with sockets of Hi Cupla Models 20, 30 and 40.
- Also available with quick connect / disconnect Tube Fitter type.

Specifications

Body material	Cupla : Steel (Chrome-plated), Aluminum Tube Fitter Type: Brass (Nickel-plated)			
Size	1/8" • 1/4"			
Tube size (for Tube Fitter end configurations)	Polyurethane : $\phi 6 \pm 0.1 \bullet \phi 8 \pm 0.15$ Nylon : $\phi 6^{+0.05}_{-0.08} \bullet \phi 8^{+0.05}_{-0.1}$ Teflon : $\phi 6 \pm 0.07 \bullet \phi 8 \pm 0.07$			
Working pressure MPa (kgf/cm ²)	1.0 {10}			
Pressure resistance MPa (kgf/cm ²)	1.5 {15}			
Seal material Working temperature range	Seal material	Mark	Working temperature range	Remarks
	Nitrile rubber	NBR (SG)	-20°C~+80°C	Standard material
	Fluoro rubber	FKM (X-100)	-20°C~+180°C	Made-to-order item(s)

• Above specifications apply only to Cuplas. Working pressure, pressure resistance and working temperature range may vary depending on tube materials you use with and temperature conditions you use under. Micro Cupla with Tube Fitter has NBR packing material only.

Max. Tightening Torque

N·m (kgf·cm)

Size	1/8"	1/4"
Torque	7 (71)	14 (143)

Flow Direction

Air flows in either direction from plug or socket side when coupled.

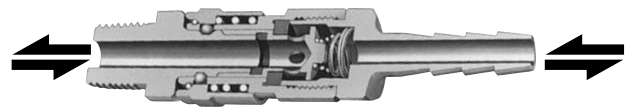

Interchangeability

Any socket and plug can be connected regardless of their end configurations.

*Can be connected with Mold Cuplas.

*When conversion socket+plug Model 02S20P is used, Super Cupla plugs can be connected with sockets of Hi Cupla Models 20, 30 and 40.

Min. Cross-Sectional Area

(mm²)

Model	01SP	02SP	Tube Fitter Type for 6mm OD tube	Tube Fitter Type for 8mm OD tube
Min. Cross-Sectional Area	19	19	12.5	19

Suitability for Vacuum

Not suitable for vacuum application in either connected or disconnected condition.

Pressure - Flow Characteristics

[Test conditions] • Fluid : Air • Temperature : Room temperature
• Tube size : $\phi 6\text{mm} \times \phi 4\text{mm}$, $\phi 8\text{mm} \times \phi 6\text{mm}$ ((Super Cupla with Tube Fitter))

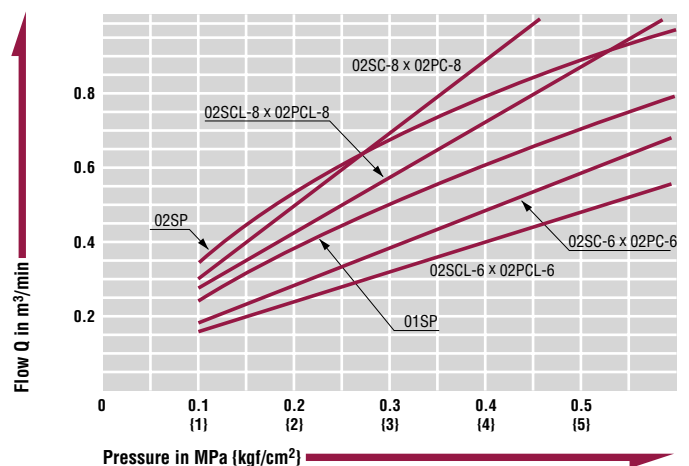

Models and Dimensions

Plug O2PH type (Hose barb)

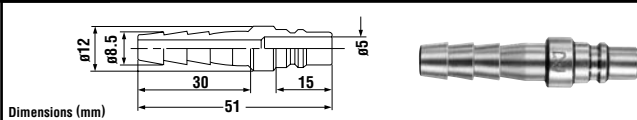

Model	Application (Hose)	Mass (g)
O2PH	1/4"	16

Plug PN type (For connection to urethane hose)

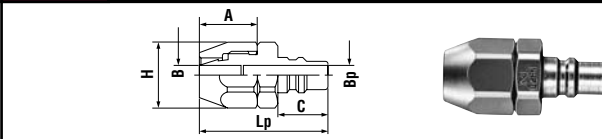

Model	Application (Hose)	Mass (g)	Dimensions (mm)					
			Lp	C	A	H(WAF)	σBp	σB
O1PN	ø5mm x ø8mm	27.6	38.5	15	17	Hex.17	6	3.8
O2PN	ø6.5mm x ø10mm	27.6	38.5	15	17	Hex.17	6	5.3

Plug PM type (Male thread)

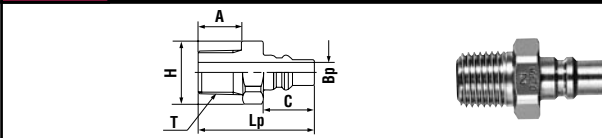

Model	Application	Mass (g)	Dimensions (mm)					
			Lp	C	A	H(WAF)	T	σBp
O1PM	Rc 1/8	12	31	15	10	Hex.12	R 1/8	5
O2PM	Rc 1/4	22.7	34	15	13	Hex.17	R 1/4	6

Plug O2PFF type (Parallel female thread)

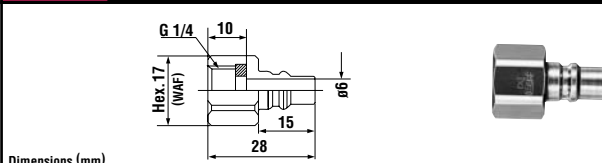

Model	Application	Mass (g)
O2PFF	G 1/4	17.7

Plug/Socket Model O2S20P (Conversion model to connect Hi Cupla socket and Super Cupla plug)

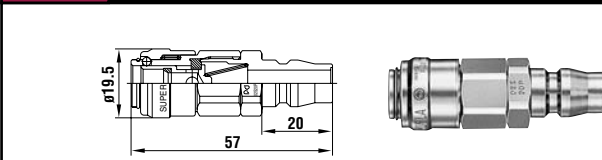

Model	Application	Mass (g)
O2S20P	Hi Cupla (Socket)	58

Plug PC type (Straight type with Tube Fitter)

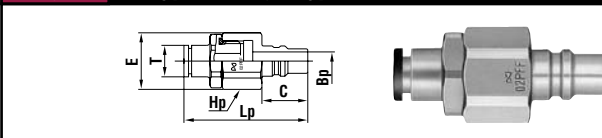

Model	Application (Tube)	Mass (g)	Dimensions (mm)					
			Lp	C	E	Hp(WAF)	σT	σBp
O2PC-6	6mm OD	28.5	(40.5)	15	18.5	Hex.17	10.3	6
O2PC-8	8mm OD	33	(47.5)	15	18.5	Hex.17	13.5	6

Plug PCL type (Straight type with Tube Fitter)

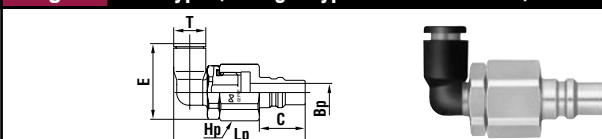

Model	Application (Tube)	Mass (g)	Dimensions (mm)					
			Lp	C	E	Hp(WAF)	σT	σBp
O2PCL-6	6mm OD	29.5	(43)	15	(25.3)	Hex.17	10.3	6
O2PCL-8	8mm OD	34.5	(46.5)	15	(32.3)	Hex.17	13.5	6

Socket O2SH type (Hose barb)

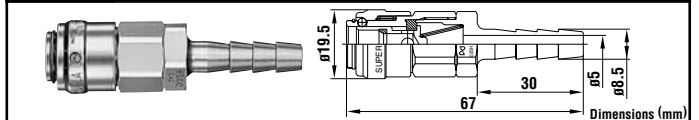

Model	Application (Hose)	Mass (g)
O2SH	1/4"	56

Socket SN type (For connection to urethane hose)

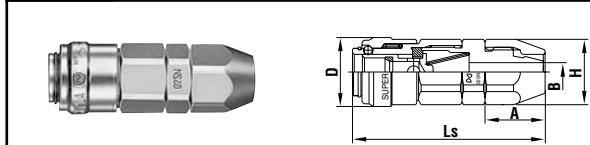

Model	Application (Hose)	Mass (g)	Dimensions (mm)				
			Ls	A	σD	H(WAF)	σB
O1SN	ø5mm x ø8mm	35	54.5	17	19.5	Hex.17	3.8
O2SN	ø6.5mm x ø10mm	35	54.5	17	19.5	Hex.17	5.3

Socket SM type (Male thread)

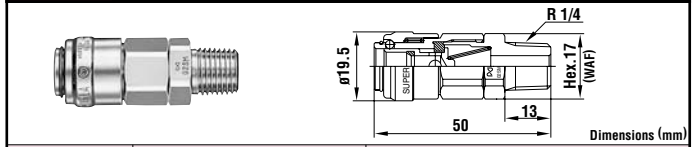

Model	Application	Mass (g)
O2SM	Rc 1/4	57

Socket O2SF type (Female thread)

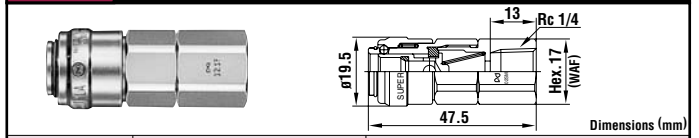

Model	Application	Mass (g)
O2SF	R 1/4	26

Socket O2SMF type (Parallel female thread)

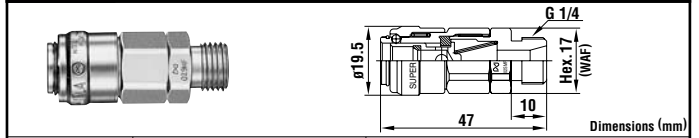

Model	Application	Mass (g)
O2SMF	G 1/4	27

Socket SC type (Straight type with Tube Fitter)

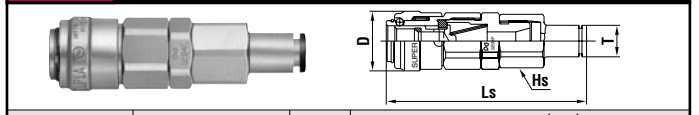

Model	Application (Tube)	Mass (g)	Dimensions (mm)			
			Ls	σD	Hs(WAF)	σT
O2SC-6	6mm OD	46	(65.5)	19.5	Hex.16	10.3
O2SC-8	8mm OD	50.5	(70)	19.5	Hex.16	13.5

Socket SCL type (Straight type with Tube Fitter)

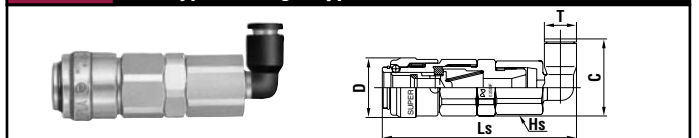

Model	Application (Tube)	Mass (g)	Dimensions (mm)				
			Ls	σD	Hs(WAF)	C	σT
O2SCL-6	6mm OD	47.5	(63.5)	19.5	Hex.16	(25.7)	10.3
O2SCL-8	8mm OD	49.5	(67.7)	19.5	Hex.16	(32.8)	13.5

Socket SCB type (Straight type with Tube Fitter)

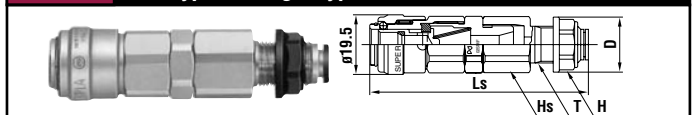

Model	Application (Tube)	Mass (g)	Dimensions (mm)				
			Ls	σD	Hs(WAF)	H(WAF)	σT
O2SCB-6	6mm OD	45.5	(71.5)	18	Hex.17	Hex.15	M12x1
O2SCB-8	8mm OD	46.5	(72)	21	Hex.17	Hex.18	M15x1