



ATRAACE Manual feed Model ARA-100A

Optional Accessories



Cutting Oil 2L per can
PN: TB01507



Supporting Magnet Ass'y
PN: TB04374



Holder MT03075 One-touch
PN: TB09279



Holder MT03075 Side-lock
PN: TB09792

Combination of Pilot Pins and Broach Cutters

Size mm dia.	PN					PN		
	Pilot Pin 08025 (A1) PN: TJ12696	Pilot Pin 08050 (A3) PN: TJ16019	Pilot Pin 08035 (A2) PN: TJ15859	Pilot Pin 08050 (A3) PN: TJ16019	Pilot Pin 08075 (A4) PN: TJ17436		Pilot Pin 12075 PN: TA9A207	
	HI-BROACH One-touch Type		JETBROACH One-touch Type				JETBROACH Side-lock Type	
	25L	50L	35L	50L	50L for stacked two plates	75L	mm dia.	75L
17.5	TK00335		TK00301	TK00380		TK01036	50	TJ17709
18	TK00336	TK00727		TK00381	TK01068	TK01003	51	TJ16651
18.5			TK00303				52	TJ16652
19	TK00337	TK00728	TK00304	TK00382		TK01004	53	TJ16653
19.5	TK00338		TK00305	TK00383			54	TJ16654
20	TK00339	TK00729	TK00306	TK00384		TK01005	55	TJ16655
20.5			TK00307	TK00385			56	TJ16656
21	TK00340	TK00730	TK00308	TK00386		TK01006	57	TJ16657
21.5	TK00341		TK00309	TK00387			58	TJ16658
22	TK00342	TK00731	TK00310	TK00388	TK00622	TK01007	59	TJ16659
22.5	TK00343		TK00311	TK00389			60	TJ16660
23	TK00344	TK00738	TK00312	TK00390		TK01008	61	TJ16661
23.5	TK00345		TK00313	TK00391			62	TJ16662
24	TK00346	TK00733	TK00314	TK00392	TK00623	TK01009	63	TJ16663
24.5	TK00347		TK00315	TK00393	TK00631		64	TJ16664
25	TK00348	TK00734	TK00316	TK00394	TK00624	TK01010	65	TJ16665
26	TK00349	TK00735	TK00317	TK00395	TK00625	TK01011	66	TJ16666
26.5	TK00350		TK00318	TK00396	TK00632		67	TJ16667
27	TK00351	TK00736	TK00319	TK00397		TK01012	68	TJ16668
28	TK00352	TK00737	TK00320	TK00398	TK00626	TK01013	69	TJ16669
29	TK00353	TK00732	TK00321	TK00399		TK01014	70	TJ16670
30	TK00354	TK00739	TK00322	TK00400		TK01015	71	TJ16671
31	TK00355	TK00740	TK00323	TK00401		TK01016	72	TJ16672
32	TK00356	TK00741	TK00324	TK00402	TK00627	TK01017	73	TJ16673
33	TK00357	TK00742	TK00325	TK00403		TK01018	74	TJ16674
34	TK00359	TK00743	TK00326	TK00404		TK01019	75	TJ16675
35	TK00361	TK00744	TK00328	TK00405	TK00628	TK01020	76	TJ16676
36			TK00602	TK00406		TK01021	77	TJ16677
37			TK00603	TK00407		TK01022	78	TJ16678
38			TK00604	TK00408		TK01023	79	TJ16679
39			TK00605	TK00409		TK01024	80	TJ16680
40			TK00606	TK00410		TK01025	81	TJ16681
41				TK00411		TK01026	82	TJ16682
42				TK00412		TK01027	83	TJ16683
43				TK00413		TK01028	84	TJ16684
44				TK00414		TK01029	85	TJ16685
45				TK00415		TK01030	86	TJ16686
46				TK00416		TK01031	87	TJ16687
47				TK00417		TK01032	88	TJ16688
48				TK00418		TK01033	89	TJ16689
49				TK00419		TK01034	90	TJ16690
50				TK00420		TK01035	91	TJ16691
51				TK00442		TK01112	92	TJ16692
52				TK00443		TK01113	93	TJ16693
53				TK00444		TK01114	94	TJ16694
54				TK00445		TK01115	95	TJ16695
55				TK00446		TK01116	96	TJ16696
56				TK00447			97	TJ16697
57				TK00448			98	TJ16698
58				TK00449			99	TJ16699
59				TK00450			100	TJ16700
60				TK00451				
61				TK00607				
62				TK00608				
63				TK00609				
64				TK00610				
65				TK00611				

Compact design
Weight reduced to **30 kg**

JETBROACH Cutters,
HI-BROACH Cutters,
and Twist Drill Bits
Can Be Used.



Max. 100 mm dia
x
75 L

Max. 32 mm dia

NITTO KOHKI CO., LTD.

Head Office
9-4, Nakaikogami 2-chome, Ohta-ku, Tokyo 146-8555, Japan
Tel : +81-3-3755-1111 Fax : +81-3-3753-8791
E-mail : overseas@nitto-kohki.co.jp

Web www.nitto-kohki.co.jp/e

DISTRIBUTED BY

This catalog is printed using environmentally friendly paper and vegetable oil inks.



Smart Energy Co., Ltd. examined this numerical value and confirmed it.
NITTO KOHKI CO., LTD. participates in an Indonesian reforestation project with print by MCP.





Specifications		ARA-100A	
Model		ARA-100A	
Power Source (Single Phase)		220 - 240 V AC, 50/60 Hz	
Electric Drill	Rated Power Consumption	W	1800
	Rated Current	A	8.2
	No-load Speed	min ⁻¹ (rpm)	110 - 210 / 330 - 660
	Morse Taper No.	W	MT3
	Rated Duty	min	30
Magnet Power Consumption		W	80
Hole Capacity	Cutter	Hole Diameter	Plate Thickness
	One-touch Type JETBROACH 35L	17.5 to 40	13 to 35
	One-touch Type JETBROACH 50L	17.5 to 65	13 to 50
	One-touch Type JETBROACH 75L	17.5 to 55	13 to 75
	JETBROACH 75L	50 to 100	13 to 75
	One-touch Type HI-BROACH 25L	17.5 to 35	13 to 25
One-touch Type HI-BROACH 50L	18 to 35	13 to 50	
Twist Drill		Max. 32 mm dia.	
Magnet Holding Power		N(kgf)	17000 (1733)
Magnet Dimensions		mm	110 x 220
Cutter Position		Straight Front to Back	mm
Adjustment		Swivel angle	30°
Power Cord Length		m	5
Mass (Weight)		kg	30
Accessories Included		<ul style="list-style-type: none"> • Pilot Pin 12075 • Side Handle • 2.5 mm Hex. Socket Screw Key • 5 mm Hex. Socket Screw Key • 6 mm Hex. Socket Screw Key • 8 mm Hex. Socket Screw Key • Drill Drift • 7 x 8 mm Spanner • Safety Chain • Guard 	

Features

Reversible Feed Handles

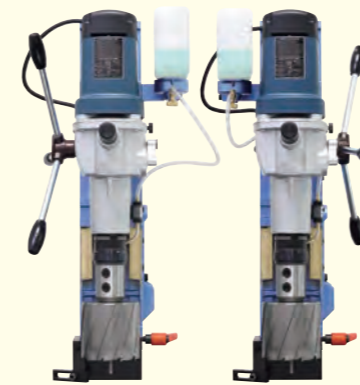

Feed handles can be positioned on the right or left hand side for ease of drilling. When changing the feed handle position, oil tank is required to be positioned opposite to the feed handles.

Drilling Position Adjustment

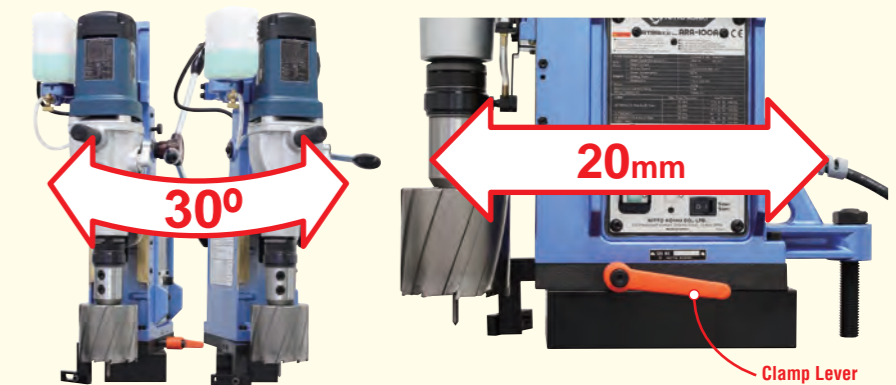

When the clamp lever is loosened, the drill position can be adjusted back and forth by 20 mm and pivoted 15 degrees to the left or right. The clamp lever can be positioned for left hand or right hand operation.

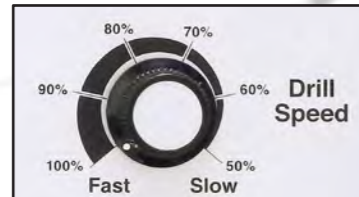
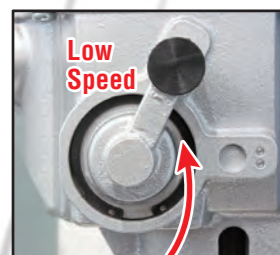

Two speed electric drill with speed adjustment

Optimum drill speed adjustment can be made to bore a hole on difficult-to-cut materials or to securely set a hole cutting position at initial cutting stage.



Slow Starting Function

Slow speed at the beginning of boring will securely set a hole cutting position.

Accessory

Holder MT03075 Side-lock



Optional accessory

Holder MT03075 One-Touch type



Mounting the cutter



Removing the cutter



Align the depression in the cutter shank with the white line on the sleeve, and then insert the cutter. Turn the sleeve counterclockwise. The cutter will come off.

One-Touch Cutter Replacement

Available in the market

Twist Drill Bit

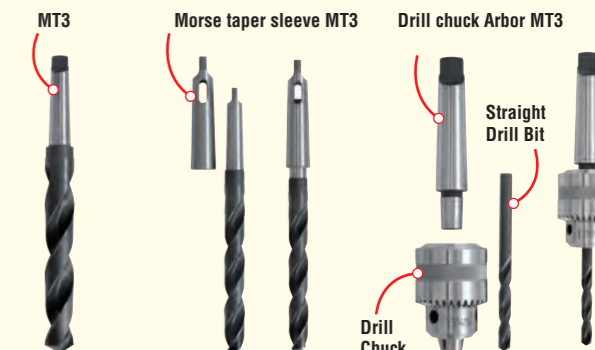

MT3 Morse taper shank drill bit can be directly installed.

Use Morse taper sleeve MT3 for other sizes than MT3

A drill chuck is required to install a straight drill bit.

Load Indication

The load indicator (LED) indicates the condition of the load with different color of LED light.

- The LED lights up in green. → The load on the drill motor is normal.
- The LED lights up in red. → The load on the drill motor is close to overload.
- The LED blinks in red. → The drill motor is overloaded.

Automatic Stop Function

As the drilling load increases, the load indicator will change in color from green to red. In addition, if excessive feeding force is applied, the load indicator will rapidly blink red and the rotation of the drill motor will slow down and stop. After the drill motor has come to a complete stop, the load indicator will slowly blink in green. To resume the rotation of the drill motor release the load and turn off the switch of the drill motor, and then turn it on.

Automatic Restart Function

If the load is released while the load indicator is blinking red, the drill motor will resume its rotation.

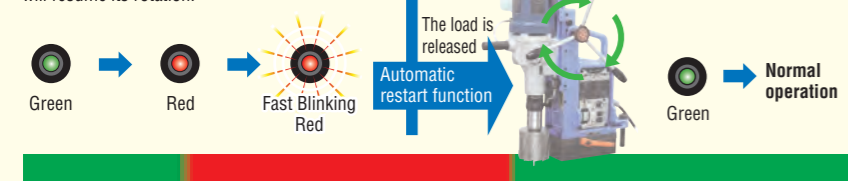

Load Indication and LED Condition

Built-in Motion Sensor

If any lateral movement or excess vibration is detected during drilling a hole, the drill motor stop instantly and the LED blink red. To resume operation, turn the magnet switch off and on.

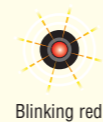

Fail-safe Restart

The magnetic field will become active, but the drill will not re-start even if power is re-supplied after accidental shutdown. The LED will blink green at this stage. Drilling can only be continued after turning on the drill switch.

Magnet Open-circuit Sensor

The drill will not start until the magnetic field is active. If malfunction occurs on the magnet, the LED will blink red slowly and the drill motor will not revolve.



Dimensions

